

ÉPÍTÉSI HELY, ÉPÍTÉSI VONAL

Lke	O	30
	4,5	1200

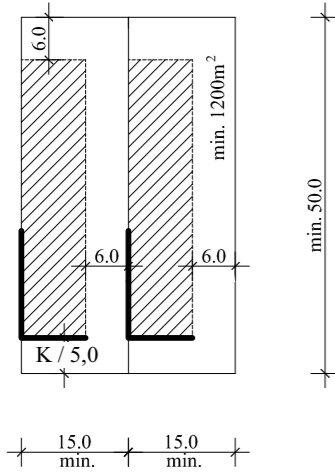

Lke	O	30
	4,5	900

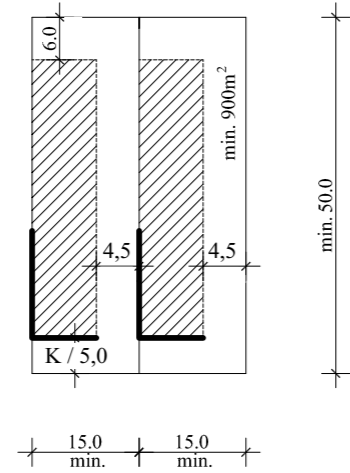

Lke	O	30
	4,5	700

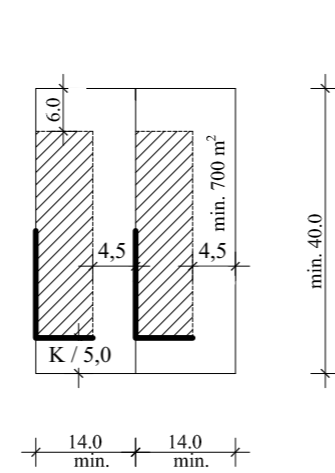

Lke	O	30
	4,5	550

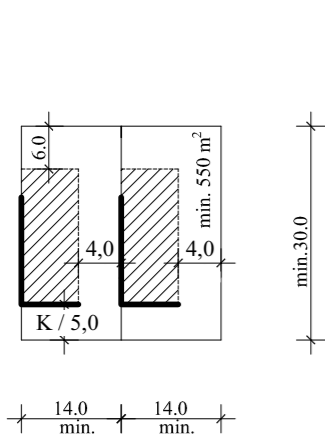

Lke	SZ	30
	4,5	900

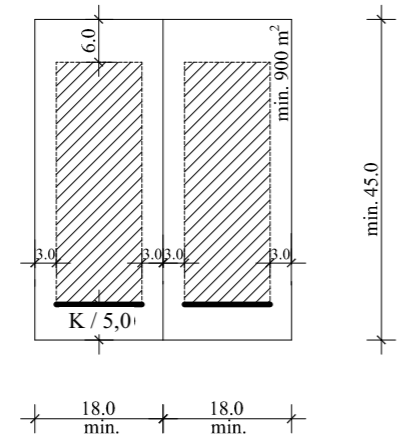

Lke	SZ	30
	7,5	900

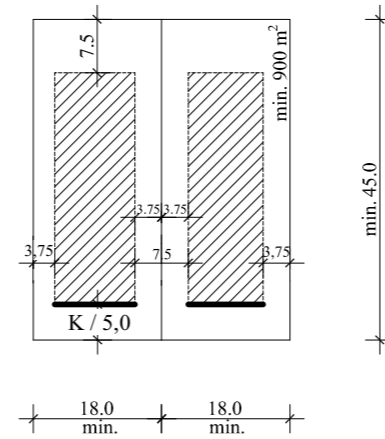

Lke	IK	30
	4,5	900

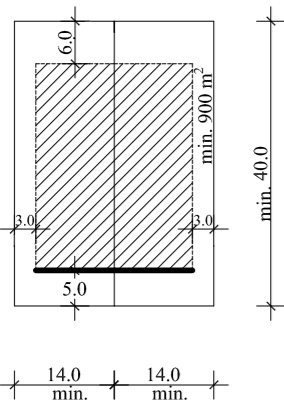

Lke	IK	30
	4,5	550

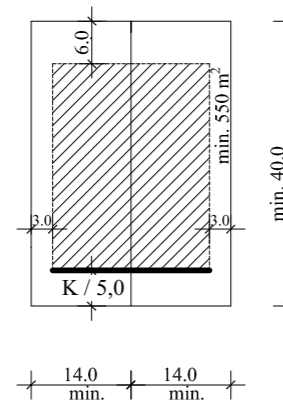

Lke	CS	30
	4,5	250

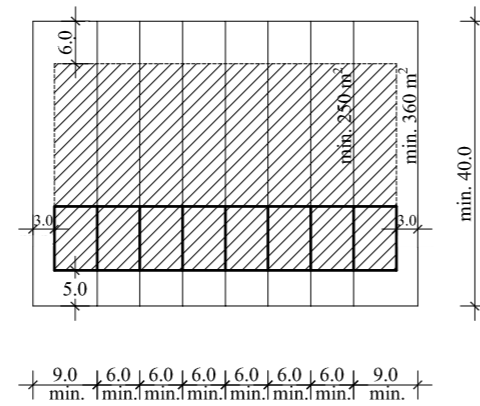

Lke	O	20
	4,5	900

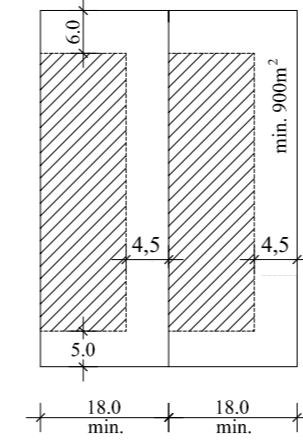

Lf	O	30
	4,5	700

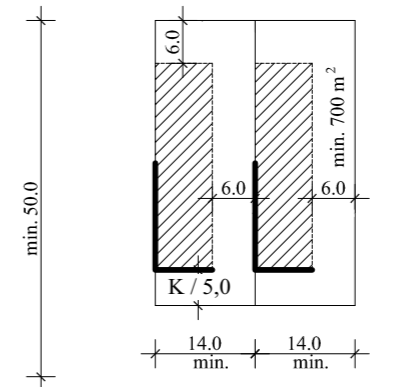

Lke*	O	30
	4,5	900

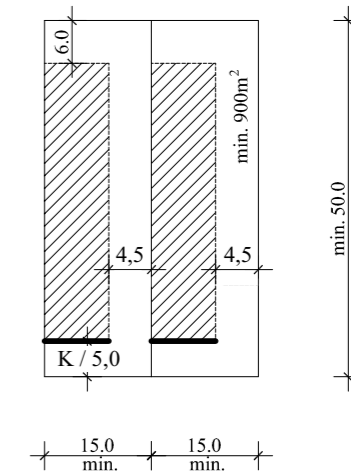

Lf	O	30
	4,5	900

Lf	O	30
	4,5	1200

Lf	KO	30
	4,5	1200

Lf	KO	30
	4,5	900

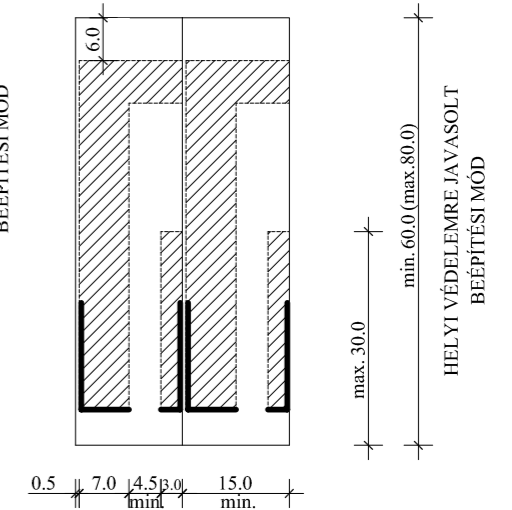
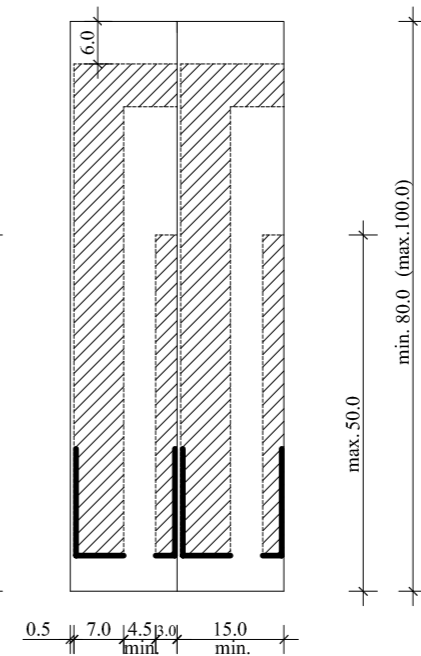
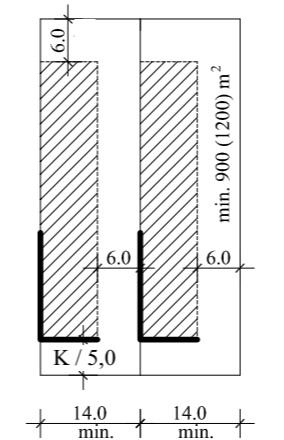

Telek beépítési minták M 1:500

Kkö	Z	40
	3,5	60

